

User Instructions

Floor standing oil fired condensing boiler conventional flue and room sealed flue

GREENSTAR HEATSLAVE II External^{ErP}

12/18, 18/25 & 25/32

For sealed central heating systems with mains fed domestic hot water

For use with Kerosene (Class C2) only.

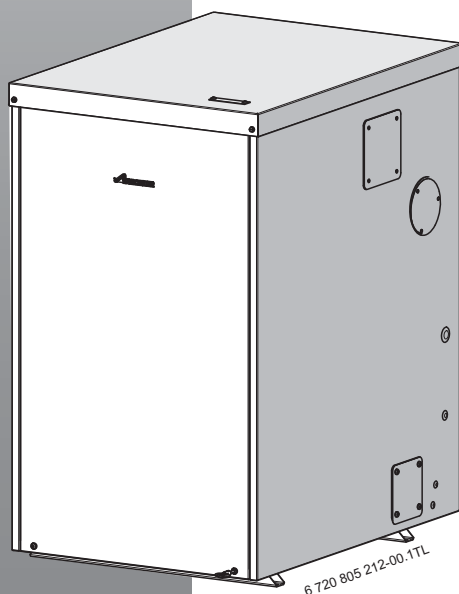

UK

User instructions & customer care guide

Please read these instructions carefully before operating your boiler.

These instructions are applicable to the Worcester, Bosch Group boiler model(s) stated on the front cover of this manual only and must not be used with any other make or model of boiler.

The instructions apply in mainland UK only and should be followed except for any statutory obligation.

If you are in any doubt contact the Worcester, Bosch Group technical support.

This boiler must be installed by a competent person, e.g. an OFTEC registered engineer, failure to install correctly could lead to prosecution.

Please leave this guide, the installation instructions and the completed checklist with the user.



NOTICE: A checklist and service interval record can be found at the rear of the Installation, Commissioning and Servicing Instruction manual.

Abbreviations

- SEDBUK Seasonal Efficiency for Domestic Boilers in the United Kingdom.
- OFTEC Oil Firing Technical Association for the Petroleum Industry.

Dedicated to heating comfort

Thank you for purchasing a Greenstar oil fired condensing boiler from Worcester, Bosch Group. The company prides itself on manufacturing boilers to the strictest quality control standards throughout every stage of production.

Worcester, Bosch Group has led the field in innovative boiler design and performance for more than 50 years. This heritage means all products are of exceptional quality and proven reliability.

The condensing range in particular, is extremely energy efficient, converting more of the fuel consumed into heat offering you economical running costs and value for money. It sits in ErP heating efficiency, band A, at the top of the energy rated boilers available.

There is also the assurance of our no-nonsense parts and labour guarantee - backed up by an optional servicing and maintenance contract to keep your boiler operating at peak condition and efficiency.

To find out more about Worcester, Bosch Group, log onto www.worcester-bosch.co.uk.

Contents

1	Introduction	3
1.1	Explanation of symbols	3
1.2	Safety precautions	3

2	General Information	4
2.1	Energy efficiency	4
2.2	Servicing	4
2.3	User caution	4

3	Using your boiler	4
3.1	Controls	4
3.2	Operating the boiler	6
3.2.1	Switching the boiler on/off	6
3.2.2	Setting central heating temperature ..	6
3.2.3	Controlling the central heating	7
3.2.4	Setting the hot water temperature ..	7
3.2.5	Domestic hot water (DHW)	7
3.2.6	Eco mode	7
3.2.7	Frost protection	8
3.2.8	System pressure	8

4	Maintenance	9
4.1	Troubleshooting	9
4.2	Fault finding	10
4.3	Maintaining your boiler	10
4.4	Servicing	10

5	General information	11
5.1	Important information	11
5.2	General notes	12

6	Energy saving 13	
6.1	Tips on energy saving	13

7	Guarantee	14
7.1	Fault or breakdown	14
7.2	Guarantee registration	15
7.3	Your guarantee	15

1 Introduction

1.1 Explanation of symbols

Warning symbols

	Safety instructions in this document are framed and identified by a warning triangle which is printed on a grey Background.
----------------------------------------------------------------------------------	-----------------------------------------------------------------------------------------------------------------------------

Key words indicate the seriousness of the hazard in terms of the consequences of not following the safety instructions.

- **NOTICE** indicates possible damage to property or equipment, but where there is no risk of personal injury.
- **CAUTION** indicates possible personal injury.
- **WARNING** indicates possible severe personal injury.

Important information

	Notes contain important information in cases where there is no risk of personal injury or material losses and are identified by the symbol shown on the left. They are bordered by horizontal lines above and below the text.
----------------------------------------------------------------------------------	-------------------------------------------------------------------------------------------------------------------------------------------------------------------------------------------------------------------------------

Additional symbols

Symbol	Meaning
1.	a numbered step in an action sequence
▶	a step in an action sequence
•	a list entry
–	a list entry (second level)

1.2 Safety precautions

Oil fumes or leaks from the boiler:

- Switch off the boiler electricity supply.
- Isolate the fuel supply to the boiler.
- Contact installer/service engineer.

This boiler must only be operated by a responsible adult who has been instructed in, understands and is aware of the boiler's operating conditions and effects.

Health and safety

The appliance contains no asbestos and no substances have been used in the construction process that contravene the COSHH Regulations (Control of Substances Hazardous to Health Regulations 1988). Where applicable, the CE mark indicates compliance with relative EU Directives.

Combustible and corrosive materials

Do not store or use any combustible materials (paper, thinners, paints etc.) inside or within the vicinity of the boiler.

The combustion air must be kept clear of chemically aggressive substances which can corrode the boiler and invalidate any warranty.

Fitting and modifications

Fitting the boiler and any controls to the boiler may only be carried out by a competent engineer in accordance with the relevant Installation Regulations.

Flue systems must not be modified in any way other than as described in the fitting instructions.

Any misuse or unauthorised modifications to the boiler, flue or associated components and systems could invalidate the warranty. The manufacturer accepts no liability arising from any such actions, excluding statutory rights.

This boiler is suitable for use with Kerosene (Class C2) only, no other fuel may be used.

Do not operate the appliance when

- The appliance, flue or system is incorrectly fitted, faulty or damaged.
- The flue terminal outlet is obstructed or damaged.
- There are fumes, fuel leaks or fuel smells from the fuel supply, appliance or internal flue system.
- The system is empty, frozen or unpressurised.
- The condensate pipe is blocked or restricted.
- The appliance clearances are inadequate.
- The air supply is restricted or vents damaged.

2 General Information

2.1 Energy efficiency

Energy efficiency information is given in the Installation, Commissioning and Servicing Instructions supplied with the appliance.

2.2 Servicing

The Service Checklist can be found at the rear of the boiler's installation instructions. It will be required in the event of any guarantee work and may be required by the local Building Control Inspector.

- ▶ Have the boiler serviced regularly by a competent, OFTEC registered engineer.
- ▶ Ensure that the service engineer completes the Service Record, at the rear of the Installation, Commissioning and Servicing Instruction manual, after each service.
- ▶ Have any work carried out only by a competent, OFTEC registered engineer.
- ▶ Always use original spares, to help maintain the efficiency, safety and reliability of the appliance.

2.3 User caution

- It is forbidden for any interference with the appliance other than those actions allowed in this document.



CAUTION: Incorrect use

- ▶ Any incorrect use can result in danger to the householder.

3 Using your boiler

3.1 Controls

To access controls:

To access controls first remove the front panel:

- ▶ Unscrew the two screws [A] on the bottom of the front panel using the tool [B] provided. The panel will drop down and can be carefully removed.
- ▶ Pull control drawer [C] fully forwards.

To replace:

- ▶ Push control drawer [C] firmly back into place.
- ▶ Push the front panel up behind the top panel, push in and secure in place with the screws [A] using tool [B].

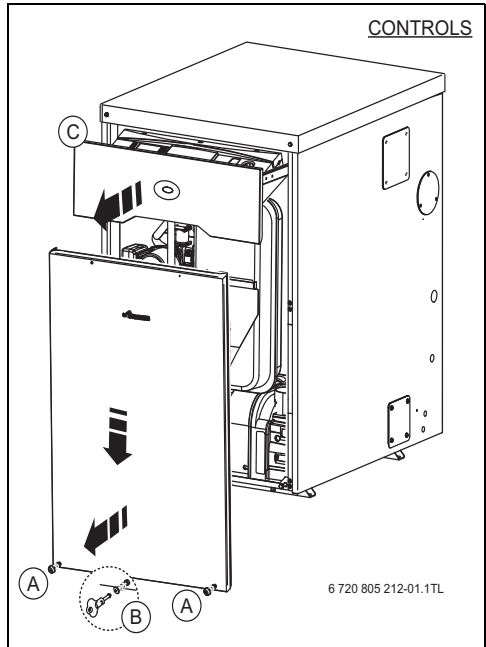
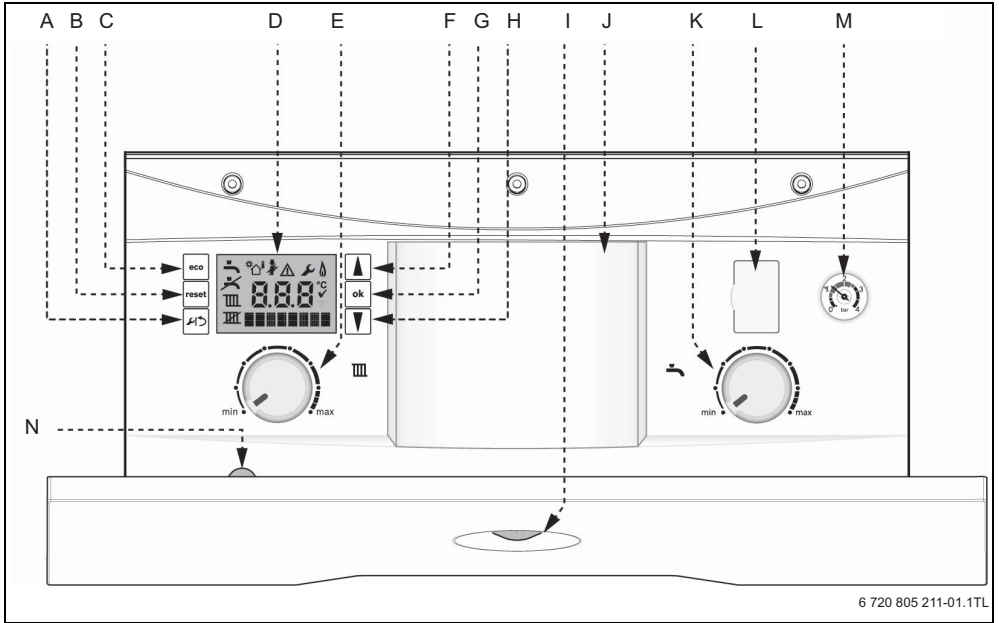

Fig. 1













6 720 805 211-01.1TL

Fig. 2

Controls:

- [A] Spanner/return button
- [B] Reset button
- [C] ECO button
- [D] Boiler LCD display
- [E] Central heating temperature control
- [F] Scroll up button
- [G] OK - Select/confirmation button
- [H] Scroll down button
- [I] Demand/fault indicator (blue)
- [J] Position for optional programmer
- [K] Hot water, heat store, temperature control
- [L] Diagnostic port (service engineer)
- [M] System pressure gauge
- [N] Burner service mode button (service engineer)

Display symbols	Description	Explanation
	All possible screen symbols (including greyed out symbols)	All possible screen symbols are displayed briefly during start up. The greyed out symbols are not required for the operation of this appliance.
	Numerical display	Displays a temperature setting or boiler status code.
	Text display	Displays ECO or Alert code
	Hot water	Displays during a hot water demand and when the heat store is reheating.
	Central heating	Displays during central heating demand.
	Alert	Displays during a fault condition with diagnostic and status code.
	Service mode	Displays when in the service menus.
	Centigrade indication	Displays next to temperature reading.
	Confirmation	Confirms a manual change.
	Weather Compensation	Displays only if Weather Compensation sensor is fitted and is active.

3.2 Operating the boiler

3.2.1 Switching the boiler on/off

- ▶ To switch on the boiler; turn on the water, oil and electricity supply to the boiler.
- ▶ Check the programmer/timer is correct and is set to ON.
- ▶ Set the room thermostat to the desired temperature.
- ▶ Open and set thermostatic radiator valves as required.
- ▶ Turn the boiler water temperature control to the required setting.
- ▶ To switch off the boiler; turn the programmer/timer to OFF for heating and hot water.

3.2.2 Setting central heating temperature

1. Turn the central heating temperature control knob to the desired flow temperature between 50 and 82°C, this will be indicated on the digital display. This is not the room temperature but the flow temperature through the radiators.

2. The radiator symbol will be displayed to confirm that the central heating setting is being changed.
3. The value is displayed during this process, press  to exit or after five seconds of inactivity the boiler display will return to the default screen.

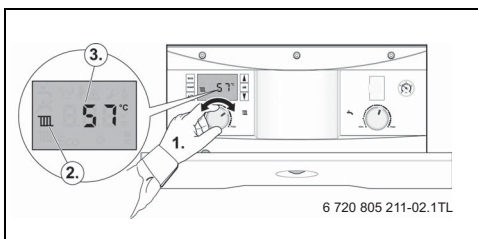

Fig. 3

3.2.3 Controlling the central heating

- ▶ Set the programmer/timer to the correct time with the required ON/OFF periods.
- ▶ Turn the room thermostat to the temperature required.
- ▶ Set thermostatic radiator valves to the required temperature for each room.

Turning the central heating off during the summer

- ▶ Turn your programmer/timer to the off position.
- ▶ Please refer to the programmer/timer manufacturer's instructions.

3.2.4 Setting the hot water temperature

The hot water temperature control knob sets the temperature of the heat store. A high setting will give a higher hot water temperature and greater quantities of hot water.

1. Turn the hot water temperature control knob to the desired level between 1 and 8, this will be shown on the digital display.
2. The tap symbol will be displayed to confirm that the hot water setting is being changed.
3. The value is displayed during this process, press to exit or after five seconds of inactivity the boiler display will return to the default screen.

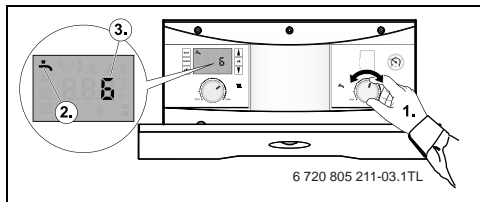

Fig. 4

3.2.5 Domestic hot water (DHW)

The GREENSTAR HEATSLAVE II is microprocessor controlled and at low DHW flow rates (washing hands etc), the burner will not fire up immediately when the tap is opened as the heat store will meet the demand, but at high flow rates (filling a bath for example) the burner will fire up to boost the heat store and meet the demand.

If DHW is OFF on the programmer, the appliance will still supply DHW using heat stored in the tank, but it will not reheat the tank, therefore the amount of water available is limited but is adequate for washing up, filling basins etc.

We recommend that DHW is timed off overnight and when the home is unoccupied to save energy. The timer should be set for at least half an hour before normal hot water demands are expected to reheat the heat store.

When reheating the heat store the controls will reclaim heat from the boiler for the tank, this means that the pump will run (and the blue light will be on) for some time after the burner has turned off whilst heat reclaiming takes place.



WARNING: Care should be taken when using slow running taps and showers, as in some circumstances, the combination of low water flow rate and high setting of the hot water control thermostat can result in very hot water.

3.2.6 Eco mode

Domestic hot water eco mode

Eco mode is an energy saving feature which alters the cycling function of the burner for heating the heat store tank. In normal operation the burner will fire more frequently between demands in order to maintain a stored temperature close to the hot water set point you have entered. In Eco mode, the burner fires less frequently between demands meaning that the heat store temperature is maintained at a lower average level, but the tank set point remains the same.

By selecting Eco mode you will be using less energy as the tank is allowed to cool a little more before reheating to the set point.

Selecting eco mode

1. Press and hold for at least four seconds to enter the energy saving Eco mode, when Eco mode is active, "Eco" will be displayed.

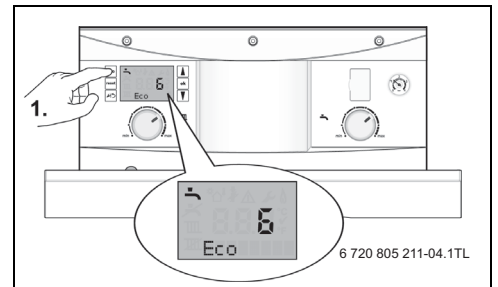

Fig. 5

Exit eco mode

- ▶ To exit ECO mode, press and hold for at least four seconds, "Eco" will disappear.

3.2.7 Frost protection

- ▶ The boiler has built in frost protection to protect the boiler, the boiler must have power for this to operate.
- ▶ If you are leaving the property unoccupied during cold weather, please leave your programmer on constant and your room thermostat set to 15°C.
- ▶ If the temperature within the boiler falls below 8°C the pump will run to circulate water and prevent the system freezing.
- ▶ If the temperature within the boiler falls below 4.5°C the boiler will fire immediately, bringing the boiler temperature up to 12°C to avoid the possibility of the system freezing.
- ▶ This process will be repeated until such time that the boiler temperature does not drop below 4.5°C.

3.2.8 System pressure

This boiler is fitted to a sealed heating system which is pre-pressurised. Your installer will advise you of the minimum and maximum pressure indicated on the pressure gauge.

- ▶ Check regularly that the pressure is maintained.

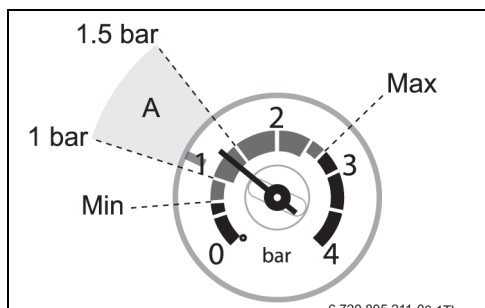

Fig. 6

Optimum system pressure when your boiler is cold (area A) and the pump is off. The indicated pressure will change as the pump switches on, for more accurate readings check pressure when the pump is not running.

- ▶ Contact your installer or maintenance engineer if a permanent significant decrease or increase in pressure is indicated on the pressure gauge.

Filling loop

If the sealed system pressure within your system drops to below 0.5 bar (shown on the pressure gauge) you will need to increase the pressure to ensure your boiler continues to run without problems.



Your installer should have informed you where to find the filling system and instructed you in its use.

Once the external filling loop has been located, follow the instructions for re-pressurising the system.

1. Unscrew blanking cap.
2. Attach the hose to the valves, screw on hand-tight.
3. Turn the handle/screwdriver slot through 90° to open valves.
4. The handle/screwdriver slot will be in line with the valves.
5. When the pressure reaches between the 1 and 1.5 bar marks (zone A), turn the handles/screwdriver slots back, through 90°, to close the valves.
6. The handle/screwdriver slot will be at 90° to the valves.
7. Remove the hose and replace the blanking caps.

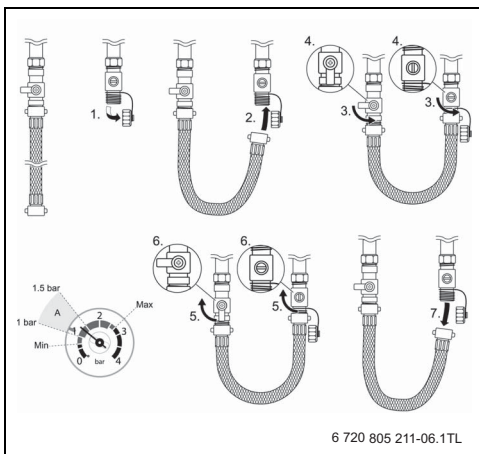



Fig. 7

4 Maintenance

4.1 Troubleshooting

Boiler alert state

Should a fault develop with this boiler (or the system), the boiler will enter into a fault conditions

1. A fault condition is indicated by a flashing blue operation/fault light and an triangular alert symbol on the display. A flashing **fault code** is also displayed, see figure 8.
This type of fault can often be cleared by pressing the Reset button .



Fault codes 9F and 855

- ▶ This is a burner lockout condition, press the Reset button to restart the burner
- ▶ If the burner fails to fire and fault 9F 855 is displayed again, check the oil supply to the boiler
- ▶ If you try more than five times to reset the boiler and fail, no more resets can be attempted and the fault code 9F 856 will be displayed, call Worcester, Bosch Group for assistance, quoting the fault codes, contact details are on the back page.

Boiler reset

1. Press the Reset button  on the fascia to clear the fault.
 - ▶ Reset and a tick ✓ symbol will be briefly displayed.
 - ▶ If the reset was successful the boiler will return to normal operation.
 - ▶ If the reset was not successful then the fault code will be displayed again, and the blue operation/fault light will continue to flash.
 - ▶ Make a note of these fault codes, in the table below as an example see figure 8, fault codes E5 and 218.
 - ▶ Contact Worcester, Bosch Group for assistance and quote any fault codes displayed.

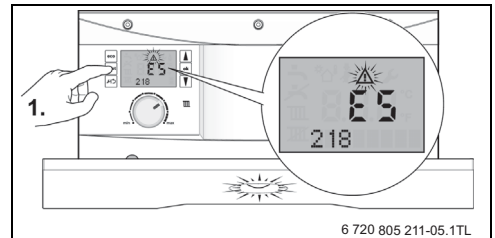

Fig. 8

Flashing fault code	Three figure number
e.g. E5	e.g. 218

Boiler stops with no fault code

In most cases these fault conditions will clear automatically when the associated fault clears e.g. waiting for an area of the boiler to cool down.

If the boiler fails to automatically reset itself after a period of 30mins, call Worcester, Bosch Group, contact details are on the back page of this manual.

4.2 Fault finding

Problem	Cause	Remedy
Boiler stops working, blue light and warning triangle flashing and fault code displayed	Internal error	Press the Reset button and the boiler should restart, if not call Worcester, Bosch Group, quoting fault codes
Boiler stops with no fault codes	Possible overheat	Wait 30 minutes for boiler to cool
Boiler stops working, blue light and warning triangle flashing and fault codes 9F 855 are displayed	Burner lockout	Press the Reset button to restart the burner. If the burner fails to fire and fault 9F 855 is displayed again, check the oil supply to the boiler
Fault codes 9F 856	More than 5 attempts at a reset during Burner lockout fault 9F 855, no more reset attempts can be made.	Call Worcester, Bosch Group, quoting fault codes
Desired room temperature is not reached	Thermostatic radiator valve(s) set too low	Increase thermostatic radiator valve setting(s)
	Room thermostat set too low	Increase room thermostat setting
	Temperature control for CH flow on boiler set too low	Increase CH flow temperature control setting
	Air trapped in heating system	Bleed radiators and recharge heating system
Desired room temperature exceeded by large amount	Radiators are too hot	Turn down thermostatic radiator valves/room stat
Room temperature rises instead of falling	Clock is incorrectly set	Check setting
No display or display unit does not respond	Momentary power failure	Switch off boiler at master switch, wait 30 seconds then switch on again
Hot water temperature too low	Hot water temperature set too low	Check setting
	Hot water not in timed period on the programmer	Check programmer settings

4.3 Maintaining your boiler

Your new boiler represents a long term investment in a reliable, high quality product.

In order to realise its maximum working life and to ensure it continues to operate at peak efficiency and performance, it is essential that servicing and maintenance checks are performed at least once a year by an OFTEC engineer or other suitably qualified person.

If you would like to know more about servicing options from Worcester, Bosch Group, please visit worcester-bosch.co.uk. Please tick the appropriate box on your warranty registration card for further details of the Worcester, Bosch Group Service Contract.

When your boiler requires servicing please contact a Worcester, Bosch Group contact centre (see inside front cover for details).

In addition to the service contract we are pleased to offer a one-off annual service or breakdown call out for your boiler.

Maintenance tips

Regularly check the oil level in the tank. Running the tank empty or low can lead to damage to the burner.

Do not obstruct the flue outlet or the air inlet.

Use in hard water areas

In exceptionally hard water areas a device to prevent scale formation may be fitted. Installation of a scale inhibitor assembly should be in accordance with the requirements of the local water company. An isolating valve should be fitted to allow for servicing.

4.4 Servicing

You must have the boiler regularly serviced by a competent, qualified OFTEC registered engineer using approved spares, to help maintain the economy, safety and reliability of the boiler. The boiler should be serviced once each year after installation unless the installation conditions and usage demand more frequent services.



The service engineer must complete the Service Record in the checklist after each service.

The completed checklist will be required in the event of any warranty work and may be required by the local Building Control Inspector.

The checklist and service interval record can be found at the rear of the Installation, Commissioning and Servicing Instructions.

5 General information

5.1 Important information



WARNING: External equipment operating at 230 Volts must not be serviced or repaired during adverse weather conditions. Do not use pressure washers or steam cleaners on this appliance or cabinet.

Fuel

This appliance is designed to use 28 second kerosene, no other fuel must be used.

Boiler location



WARNING: This boiler must not be installed where there is a potential for excessive ground water coverage.

To prevent "wetting" it is recommended that the flue terminal faces away from walls.

Never allow the flue terminal or air inlet to become obstructed by plants or any other objects.

This boiler is only suitable for installing externally at a suitable location onto a fixed, permanent, rigid surface capable of supporting the boiler weight. Wood and tarmac hardstandings are not recommended.

The boiler must be installed on a flat level surface to ensure that condensate does not enter the primary heat exchanger.

The cabinet is not load bearing, and only provides weather protection for the boiler inside.

There must be sufficient hard standing and access around the boiler for servicing.

Installation & servicing clearances

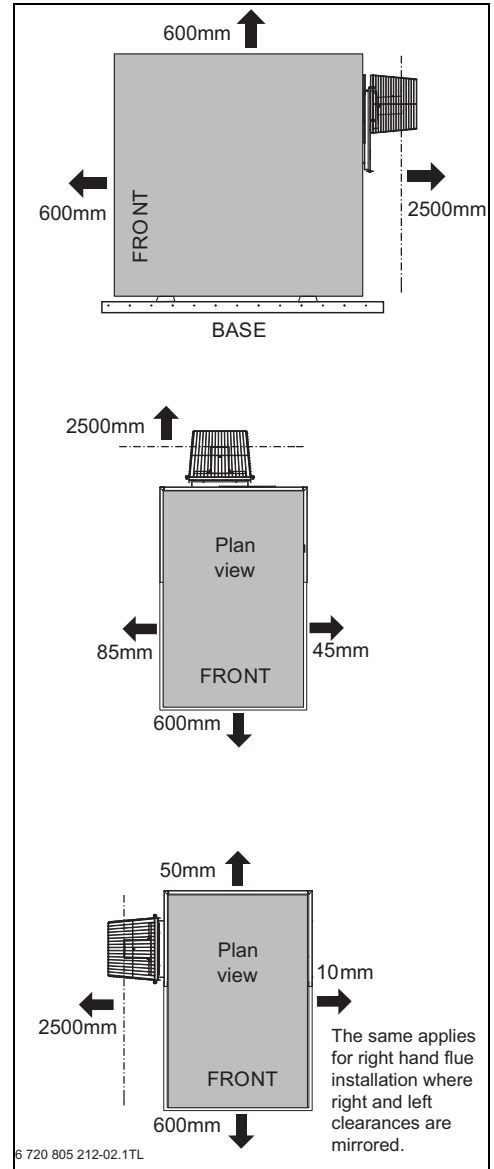

Fig. 9

5.2 General notes

To get the best from your boiler, please read these instructions carefully.

Central heating systems

During the first few hours of operation of the central heating system, check that all radiators are being heated at an even rate. If the top of a radiator is at a lower temperature than the bottom then it should be vented by releasing air through the venting screw at the top of the radiator. Ask your installer to show you how this is done. Repeated venting will reduce the quantity of water in the system and this must be replenished for safe and satisfactory operation of the boiler.

When excessive venting or water leaks are found in the system you must contact a service engineer to inspect the installation and rectify any fault.

Only use additives compatible with the boiler and system. Use of incompatible additives can cause damage and will invalidate the boiler guarantee.

Condensate drain

This is a condensing boiler and the terminal will, at times give out a plume of water vapour. This is quite normal.

The boiler also produces quantities of condensate which is discharged regularly via a pipe to drain. This pipe must not be blocked or altered in any way.

Clearances - Service

Your installer will have provided adequate space around the boiler for safety and servicing access.

Do not restrict this space with the addition of cupboards, shelves etc. next to the boiler.

Room thermostat

A room temperature controller must be fitted to control the central heating. Refer to instructions supplied with the thermostat for information on siting and setting.

Thermostatic radiator valves

It is recommended that this type of valve is fitted to all but one of the radiators (or at least those in the sleeping accommodation). The remaining radiator, which must be where the room thermostat is located, should be un-controlled and must be left open.

6 Energy saving

6.1 Tips on energy saving

Room thermostats

Reducing the setting of the room thermostat by 1°C can reduce fuel consumption by up to 10%.

New control systems

Upgrade your heating control system with the latest equipment available. The minimum level of control for a heating system is a programmer, interlocking room thermostat and thermostatic radiator valves.

Radiators

More often than not radiators will be sited underneath a window, so the warm air from the radiator heats the colder incoming air from the window.

The performance of the radiator will be affected if the curtains are allowed to drape over the radiator or shelves are fitted above it.

The positioning of furniture and tables in front of the radiator should also be avoided.

It is advisable to manually adjust all radiator valves every 2-3 months to prevent them from sticking. It is also important that the plastic tops of all valves are always in position and not cracked or damaged to help prevent accidents. Care should be taken when vacuum cleaning carpets to avoid damage to valves and pipework.

The heating system and the outputs of the radiators have been carefully selected by your installer. The temperature obtainable in any given room is dependent on all radiators being operated at the same time. If you decide to turn off radiators in unused rooms, spare bedrooms etc., you may experience slightly lower room temperatures in rooms adjacent to unheated rooms.

Heating economically

The boiler is designed to provide a high level of comfort while keeping oil consumption and the resulting environmental effect as low as possible.

The central heating control on the boiler should be set as low as possible while still maintaining a comfortable room temperature.

The temperature of each room can be set individually using the thermostatic radiator valves (except the primary room with the room thermostat).

Roof insulation

Around 30% of the heat loss from a property is through the roof. Replace any old insulation with new insulation, preferably to a minimum thickness of 200mm.

Window frames

Single glazed windows, particularly those with steel frames, can lose a great deal of heat.

Consideration should be given to replacement with PVCu or wooden framed double glazed units.

Curtains

Lined curtains, or heavier full length curtains can provide excellent insulation. However, always ensure that the curtains do not drape over radiators.

Draughts

Try to ensure that draughts around doors, windows, letterboxes and keyholes etc., are reduced by using a suitable draught excluder.



WARNING:

- ▶ Do not block or seal any air vents that are installed to ensure the central heating boiler (or other appliance) operate safely.

7 Guarantee

7.1 Fault or breakdown

This boiler is supported in mainland UK by Worcester, Bosch Group, part of Bosch Thermotechnology Ltd.

Specialist trained, Worcester, Bosch Group Service Engineers are available to attend in the unlikely event that a breakdown occurs on this boiler.

No charge will be made for parts and/or labour providing

- ▶ A boiler fault is found and the boiler has been installed within the guarantee period. Reasonable evidence of this must be supplied on request.

A call-out charge will be made where

- ▶ The boiler has been installed for longer than the guarantee period.
- or-
- ▶ Our Field Service Engineer finds no fault with the boiler (→ Note).
- or-
- ▶ Evidence cannot be provided that the first year service inspection has been carried out. (i.e. an entry in the service interval record found at the rear of the boiler installation and servicing manual).
- or-
- ▶ The cause of breakdown is misuse or with other parts of your plumbing/heating system, or with equipment not supplied by Bosch Thermotechnology Ltd.



NOTICE: No boiler fault is found on over 30% of all service call outs.

Please read this guide carefully to gain a good understanding of the operation of your boiler. In the case of a suspected fault, refer to the fault finding section of this guide.

If in doubt contact our Technical Support

In the event of an boiler fault or breakdown please contact our Service Department. Your service administrator will arrange for an Engineer to call with the minimum of delay. Under normal circumstances this will be from 1 to 3 working days (excluding weekends) for priority breakdown situations (no hot water and/or heating).

Invoices for attendance and repair work carried out on this boiler by any third party will not be accepted.

Boiler data label

The data label can be found on the inside of the right hand side panel.

To access first remove the front panel:

- ▶ Unscrew the two screws [A] on the bottom of the front panel using the tool [B] provided. The panel will drop down and can be carefully removed.

To replace:

- ▶ Push the front panel up behind the top panel, push in and secure in place with the screws [A] using tool [B].

(You can record this information on the inside back cover of this manual.)

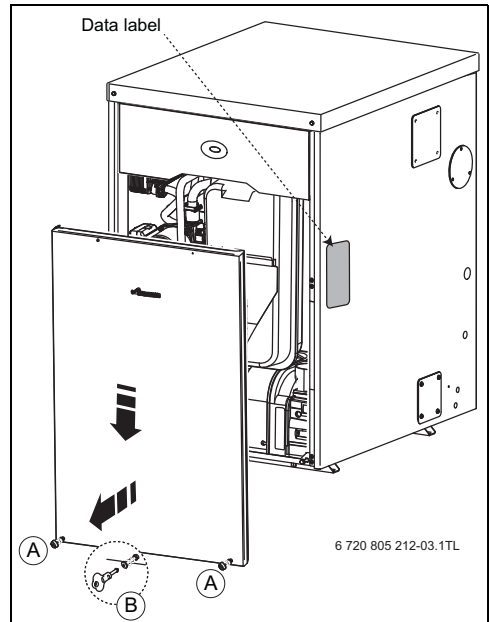

Fig. 10

7.2 Guarantee registration

You should complete and return the postpaid Guarantee Registration Card within 30 days of installation.

Returning your card will register you as the owner of your new boiler and will assist us in maintaining an effective and efficient customer service by establishing a reference and permanent record for your boiler.

This does not affect your statutory rights.

For your own records
Model
Serial number (See identity label inside boiler casing)
Type/size
Date of installation
Installer details

7.3 Your guarantee

This boiler is guaranteed against faulty materials or workmanship from the date of installation subject to the following conditions:

- ▶ During the period of this guarantee any components of the unit which are proved to be faulty or defective in manufacture will be exchanged or repaired free of material charges and free of labour charges if repaired directly by Bosch Thermotechnology Ltd.
- ▶ The householder may be asked to prove, when requested, the date of installation, that the boiler was correctly commissioned and, where appropriate, that the 12 month service inspection has been carried out to the satisfaction of Bosch Thermotechnology Ltd.
This should be documented in the Oil Boiler Commissioning Checklist and Service Interval Record in the back of the Installation, Commissioning and Servicing manual.
- ▶ Bosch Thermotechnology Ltd will not accept responsibility for damage caused by faulty installation, neglect, misuse or accidental damage and non-observance of the instructions contained in the Installation and Users Instructions manuals.
- ▶ The boiler has been used only for normal domestic purposes, for which it was designed.
- ▶ This guarantee applies only to equipment purchased and installed in mainland UK.

This guarantee is given in addition to all your normal statutory rights.

Worcester, Bosch Group is a brand name of Bosch Thermotechnology Ltd.

Guarantee registration

Your Greenstar appliance carries a guarantee against faulty material or manufacture subject to Terms and Conditions. To read the full Terms and Conditions please visit us on-line at www.worcester-bosch.co.uk/guarantee. The guarantee registration form is available on the same page and can be completed and submitted electronically. Alternatively, please telephone one of our Guarantee Registration advisors on 0330 123 2552. Your statutory rights are not affected by the manufacturer's guarantee.



If the boiler fails to give complete satisfaction, please make the general checks shown on the back page this manual before calling for a service engineer.

General checks before calling a Service engineer

1. Oil level in the tank?
2. Power to the boiler?
3. All control settings?



No boiler fault is found on over 30% of all service call outs.

Please read the fault section of the manual before contacting our service team.

WORCESTER, BOSCH GROUP:

TECHNICAL SUPPORT:	0330 123 3366
APPOINTMENTS:	0330 123 9339
SPARES:	0330 123 9779
LITERATURE:	0330 123 9119
TRAINING:	0330 123 0166
SALES:	0330 123 9669

Worcester, Bosch Group
Cotswold Way, Warndon, Worcester WR4 9SW.
Tel. 0330 123 9559
Worcester, Bosch Group is a brand name of
Bosch Thermotechnology Ltd.

worcester-bosch.co.uk

6 720 813 722 (2014/09)



WORCESTER
Bosch Group